

DESY –MHFe-  
Technical Note 19-03  
April 2019

# **Proposal of an RF System for PETRA IV**

Michael Ebert

*Deutsches Elektronen-Synchrotron DESY  
Hamburg, Germany*

# Proposal of an RF System for PETRA IV

M. Ebert, MHFe

April 2019

## INTRODUCTION

The role of an rf acceleration system of a storage ring is to generate a sufficient beam-accelerating voltage to compensate beam energy losses caused by synchrotron radiation in bending magnets and in insertion devices. Since 2009 the rf system of the PETRA III storage ring generates a voltage of 20 MV at a frequency of 499.665 MHz and accelerates an electron beam with a current of 100 mA for synchrotron-radiation users. The needed rf power is generated by klystrons in two rf stations and is supplied to twelve 7-cell cavities in a straight section of the PETRA III storage ring.

In upgrading the storage ring for PETRA IV the energy losses by radiation in bending magnets and in insertion devices are going to decrease from 4.66 MeV per turn to 4.02 MeV per turn. Together with the nearly two orders of magnitude smaller momentum compaction factor the required rf voltage can be reduced to 8 MV. This lower needed rf voltage makes it reasonable to replace the more than 35 years old 7-cell cavities by state of the art single-cell ones. By replacing the twelve 7-cell cavities by the same amount of single-cell cavities, each would have to supply the critical high voltage of 667 kV. In order to reduce the risk of cavity vacuum arcs and as a consequence the impact on the beam the installation of 24 single-cell cavities is planned.

Lifetime and emittance of PETRA IV will be negative affected by Touschek and by intrabeam scattering. As a countermeasure harmonic cavities are going to be installed to lengthen the bunches and thereby to lower their charge densities.

## FUNDAMENTAL RF SYSTEM

### Cavities

In order to suppress coupled-bunch instabilities arising from the impedances of parasitic resonant cavity modes a single-cell cavity with a broadband higher order mode (HOM) damping scheme has been designed for 3rd generation synchrotron radiation sources [1]. Single-cell cavities using this HOM damping scheme are foreseen to provide the rf voltage for PETRA IV.

The relevance of a given cavity impedance spectrum for the excitation of multibunch instabilities in a storage ring is best described by the threshold impedance [2]. The threshold impedance  $Z^{thresh}$  can be obtained by equating the radiation damping time with the respective multibunch instability rise time. The equations for the longitudinal and transverse case are:

$$Z_{\parallel}^{thresh.} = \frac{1}{N_C} \cdot \frac{1}{f_{\parallel HOM}} \cdot \frac{2 \cdot E \cdot Q_S}{I_B \cdot \alpha \cdot \tau_S} \qquad Z_{\perp x,y}^{thresh.} = \frac{1}{N_C} \cdot \frac{1}{f_{rev}} \cdot \frac{2 \cdot E}{I_B \cdot \beta_{x,y} \cdot \tau_{x,y}} ,$$

where  $N_C$  is the number of cavities,  $f_{||HOM}$  is the longitudinal HOM frequency,  $E$  is the beam energy,  $I_B$  is the average beam current,  $Q_s$  is the synchrotron tune,  $\alpha$  is the momentum compaction factor,  $f_{rev}$  is the revolution frequency,  $\tau_{x,y,s}$  are the damping times and  $\beta_{x,y}$  are the beta functions at the cavities.

In this consideration the conservative assumption has been made, that every HOM coincides with an instability driving beam frequency and that all cavities have identical impedances. With these expressions the threshold impedances had been calculated for PETRA IV and for two other synchrotron radiation sources using the so-called *BESSY HOM damped cavity* already since some time. In **Fig. 1** the threshold impedances are plotted together with the HOM impedances of the prototype cavity [3]. The large space between HOM impedance and stability threshold of about factor 8 in longitudinal direction and factor 2 in transverse direction guarantees a low tendency to coupled-bunch instabilities in PETRA IV and offers space for the not yet considered impedance contribution of the harmonic cavities.

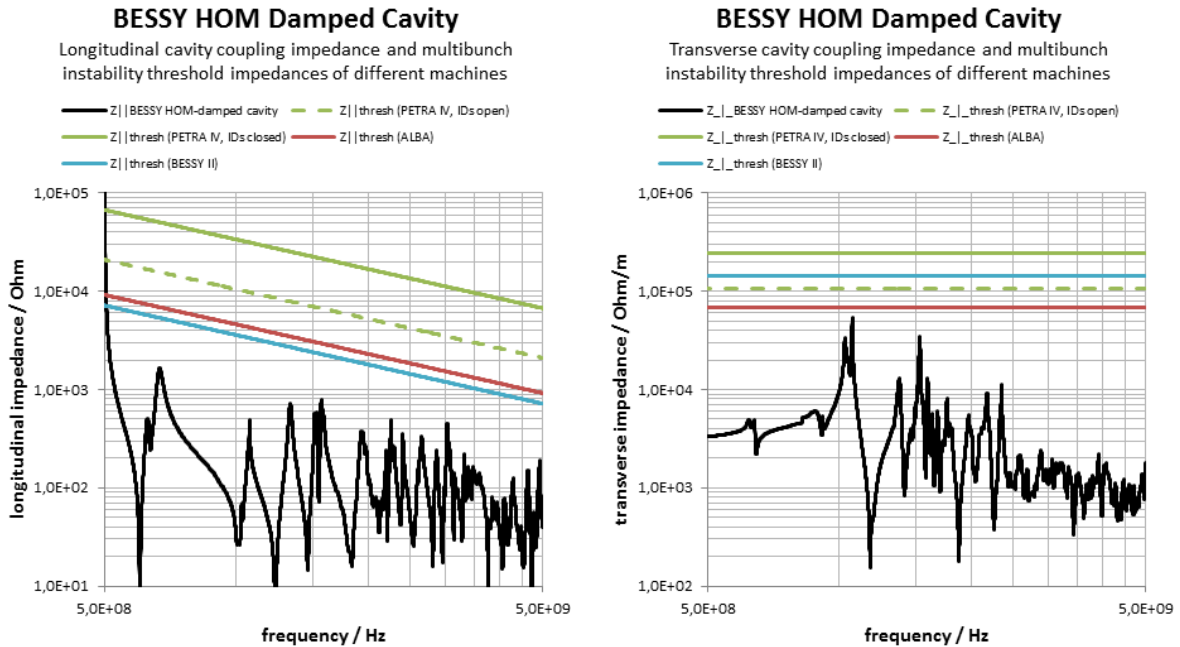

**Fig. 1:** Impedance distributions of resonant modes trapped into the cavity calculated with MAFIA. The coloured lines show the thresholds of instabilities for PETRA IV (green) and for other machines already running this cavity type

BESSY HOM damped cavities operate at gradients up to 1.7 MV/m at ALBA and at BESSY II. In order to reduce the risk of cavity vacuum arcs a cavity voltage gradient of about 1 MV/m is chosen for PETRA IV (at PETRA III the cavity voltage gradient is 0.79 MV/m). The less challenging gradient requires the installation of 24 cavities. The large number of cavities has the additional advantage that a single cavity fault has merely little impact on the beam. The required power to generate the accelerating voltage is 16.3 kW per cavity. The beam loading power at 200 mA beam current is 33.3 kW per cavity. Taking 5 % transmission loss in account, the power to supply one cavity is 52.1 kW. Each cavity is powered by its own solid-state amplifier transmitter. **Fig. 2** shows a cut-view of the BESSY HOM damped cavity with the star-shaped arranged damping waveguides and a real exemplar on a test-stand at BESSY.

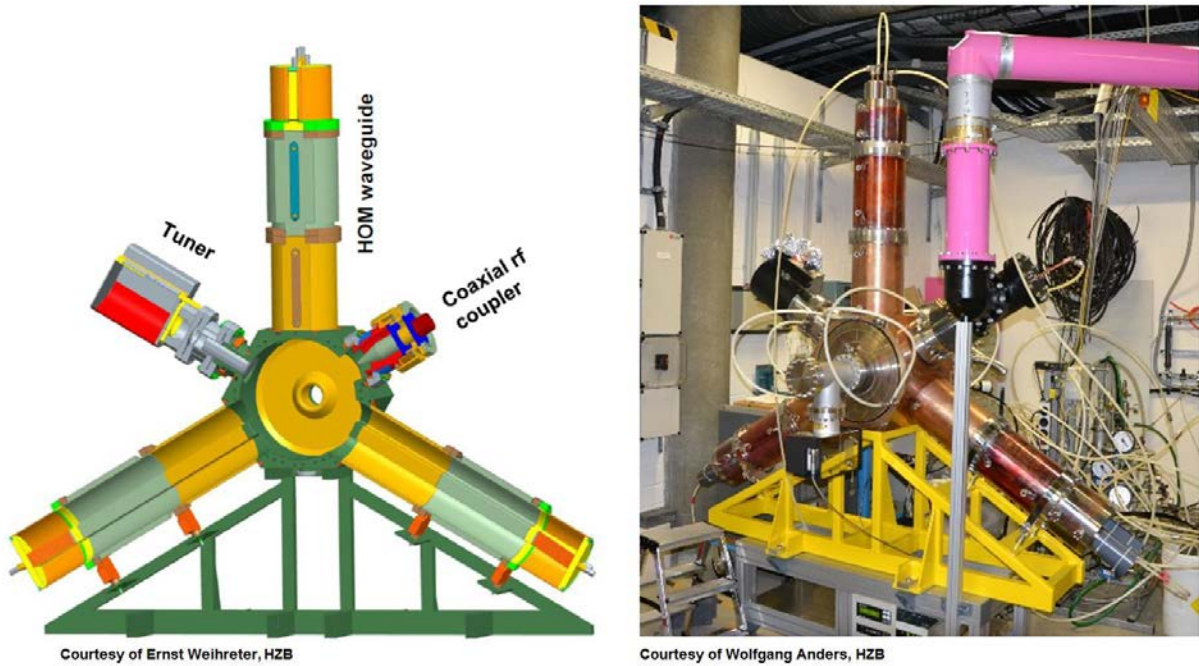

**Fig. 2:** Left: Cut view of the BESSY HOM damped cavity with the star-shaped arranged damping waveguides. Right: Cavity on a test-stand at BESSY

## Transmitters

Due to historical reasons PETRA III is driven by the rf power of two transmitters each equipped with two 800 kW klystrons. If a fault occurs in this structure, at least one transmitter will be switched off. This means that half of the accelerating voltage will be missed and the beam will be lost. To minimize the influence of rf faults on the beam, it is reasonable to assign each cavity a dedicated transmitter. Instead of klystron or IOT transmitters, solid-state amplifier transmitters are preferred for the PETRA IV rf systems. Meanwhile solid-state amplifiers (SSA) for the required rf power range are available from various manufacturers [4], [5]. Key benefits of solid-state amplifiers (SSA) are:

- Easy maintenance because of elimination of high voltage handling.
- No experienced and today rare tube specialists are required for fault diagnosis and repair.
- High modularity of the amplifier elements associated with redundancy makes SSAs very reliable.
- Significantly less rf noise compared to klystron or IOT transmitters.

## HARMONIC RF SYSTEM

Both, the negative effects of lifetime and emittance of PETRA IV by Touschek and by intrabeam scattering, can be reduced by using higher harmonic cavities (HHCs). These cavities lengthen the bunches and thereby reduce their charge density [6]. If another voltage is added to the main rf voltage with an amplitude and a phase in such a way that the slope at the bunch centre is zero, the bunch will lengthen and the peak charge density will decrease. Higher harmonic cavities have been used successfully for many years in second and third generation light sources in both in active as well

as in and passive configurations. The frequency ratio between the harmonic and the fundamental rf is basically freely selectable in a wider range. A large frequency ratio will result in a lower voltage of the harmonic cavities. However, the flat bottom of the potential well will shrink as well. For practical reasons, one usually chooses frequency ratios in the range of two to four between the harmonic and the fundamental rf.

The required harmonic rf voltage for a flat potential at bunch transition is:

$$V_{HHC_{opt.}} = V_{rf} \sqrt{\frac{1}{n^2} - \frac{1}{n^2 - 1} \cdot \left( \frac{U_0}{e_0 V_{rf}} \right)^2} ,$$

where  $n$  is the order of the harmonic,  $U_0$  is the energy loss per turn and  $V_{rf}$  is the voltage of the fundamental rf system. For PETRA IV  $n = 3$  was chosen. The energy loss per turn is  $U_0 = 4.0 \text{ MeV}$  and the rf voltage  $V_{rf} = 8.0 \text{ MV}$ . This gives an optimum value for the harmonic voltage of  $V_{HHC_{opt.}} = 2.26 \text{ MV}$ . See curves of rf components and potential well in **Fig. 9.1**. With some safety margin the system is designed for  $V_{HHC} = 2.4 \text{ MV}$ . The number of harmonic cavities required is scaled from the fundamental rf system. A three times higher frequency leads to three times shorter cavities. If one allows the same gradient as for the fundamental cavities of about  $1 \text{ MV/m}$ , 24 harmonic cavity cells are required. It is planned to make use of the downscaled BESSY HOM damped cavity, currently under development in a collaboration between CERN and ALBA. The shunt impedance  $R_S$  of those single cell harmonic cavity should be  $R_S = 1.5 \text{ M}\Omega$  [7]. The dissipated power  $P_{HHC}$  of such one single cell harmonic cavity then is:

$$P_{HHC} = \frac{\left( V_{HHC} / 24 \right)^2}{2 \cdot R_S} = \frac{(100 \text{ kV})^2}{2 \cdot 1.5 \text{ M}\Omega} = 3.33 \text{ kW} .$$

In case of using a passive harmonic system the cavity power is generated by the beam itself, but for several reasons (different beam currents for brightness and timing mode, uneven bunch pattern with gaps during filling) an active harmonic system seems to be essential for PETRA IV.

Transient beam loading effects along the bunch train could significantly degrade the total amount of bunch lengthening and thus the lifetime improvement will be degraded [8]. Transient beam loading could probably be counteracted by a feed forward beam loading compensation via the harmonic power transmitter. Due to the large circumference of the PETRA IV ring the revolution harmonics are just  $130.12 \text{ kHz}$  apart in case of an uneven bunch pattern. The unloaded bandwidth of the harmonic cavities is about  $90 \text{ kHz}$  and thus in the same range. In consequence not only the harmonic component  $n f_{rf} = n \cdot h \cdot f_{rev}$  induces a significant voltage in the harmonic cavities but also a couple of neighbouring revolution harmonics. Due to the fact that the harmonic cavities have to be detuned according to the beam current with

$$\Delta f_{HHC} = \frac{R_S \cdot n \cdot f_{rf}}{V_{HHC} \cdot Q_0} \cdot I_B$$

by several  $100 \text{ kHz}$  with respect to  $n f_{rf}$ , the amplitudes of the higher neighbouring revolution harmonics may even be dominant. For PETRA IV an extreme uneven bunch pattern with just the half ring filled with 40 times 20 bunches has been simulated. The simulation included the beam spectrum from the 1<sup>st</sup> revolution harmonic below  $n f_{rf}$  to the 5<sup>th</sup> revolution harmonic above  $n f_{rf}$ . It turned out

that under this conditions the 1<sup>st</sup> revolution harmonic above  $nf_{rf}$  is 20% stronger than  $nf_{rf}$  and the potential well is deformed accordingly as shown in **Fig. 9.2**. The potential well can be flattened again by increasing the harmonic transmitter power from  $P_{HHG} = 3.11 \text{ kW}$  to  $P_{HHG} = 28.4 \text{ kW}$  per harmonic cavity and an additional phase shift of  $\phi_{HHG} = -32^\circ$ . See **Fig. 9.3**. A more elegant solution would be a stronger coupling of the harmonic cavities. Calculations with different coupling factors for the harmonic cavities show an optimum coupling factor of  $\beta = 5.3$  with respect to the required harmonic transmitter power for the simulated uneven bunch pattern with just the half ring filled. Choosing  $\beta = 5.3$  the potential well can be flattened again by increasing the harmonic transmitter power from  $P_{HHG} = 3.11 \text{ kW}$  to  $P_{HHG} = 10.5 \text{ kW}$  per harmonic cavity and an additional phase shift of  $\phi_{HHG} = -27^\circ$ . See **Fig. 9.5**.

## TECHNICAL LAYOUT OF THE RF SYSTEMS

To avoid a single point of failure the PETRA IV rf is going to be divided into 6 independent and uniform rf systems with four fundamental cavities and four higher harmonic cavities. Each cavity is supplied by its own SSA transmitter as shown in **Fig. 3**. In case of a fundamental cavity or a transmitter fault the missing accelerating voltage can be compensated by the remaining three cavities of this rf system by raising the cavity supply power from 52.1 kW to about 76 kW. Even if one of the 6 rf systems is already out of service and a fundamental cavity or transmitter fault occurs in one of the remaining five rf systems the trip can be compensated by raising the cavity supply power from 67 kW to 105 kW. The cavity voltage of the remaining three cavities of the affected system then must increase to 533 kV. However, even with well-conditioned cavities at good vacuum conditions this voltage includes a high arcing risk. In addition to the correction of the missing accelerating voltage, transient phase correction will also be required to counteract the excitation of synchrotron oscillations [9], [10].

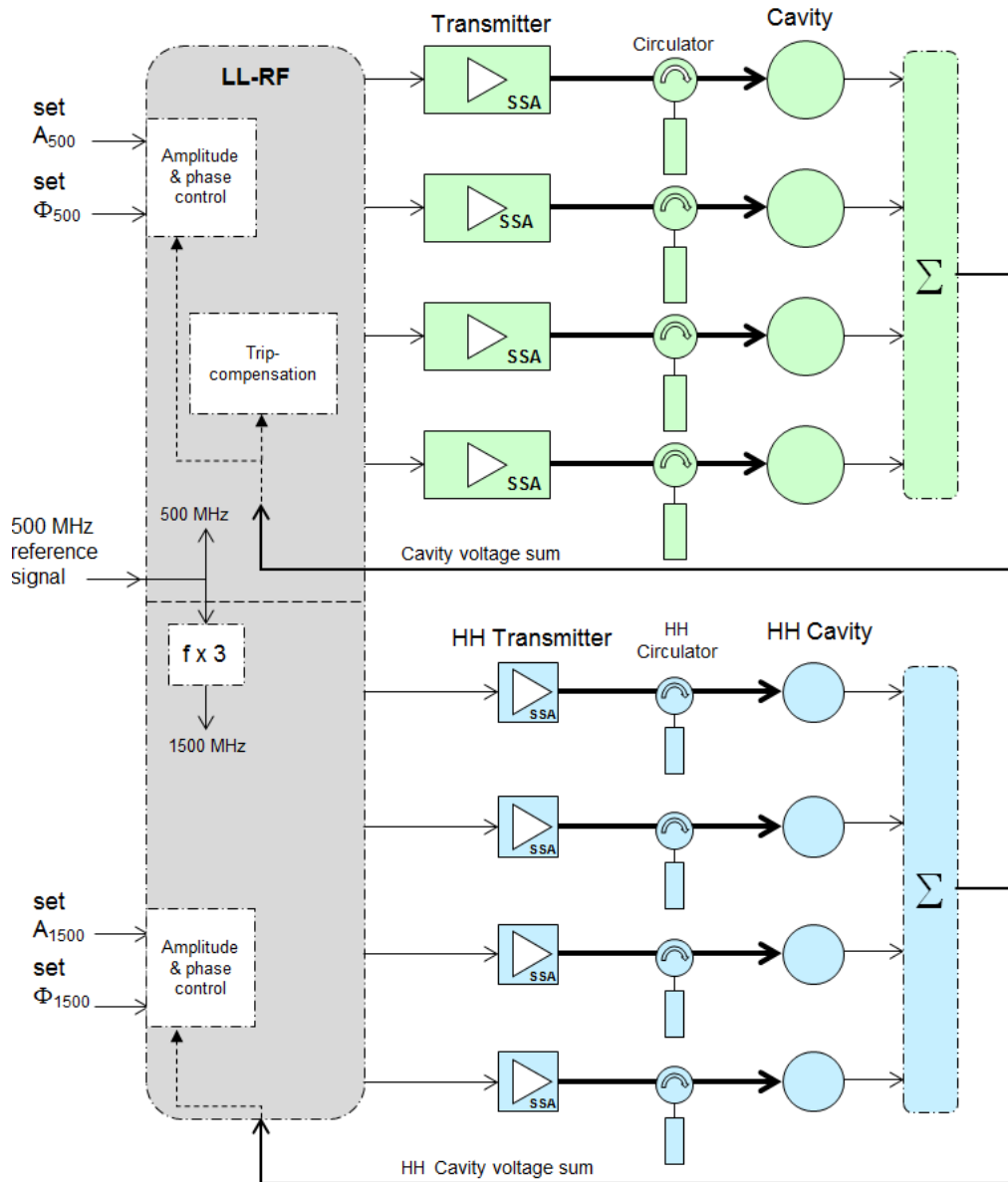

**Fig. 3:** One out of 6 independent and uniform rf systems with four fundamental cavities and four harmonic cavities each and the related transmitters and the common low level rf system

### Nominal Beam Operation of the Fundamental RF

At nominal beam operation each cavity delivers 1/24 of the required rf voltage. The needed rf power is:

$$P_{Cin} = P_{Cdiss} + P_B$$

with 
$$P_{Cdiss} = \frac{(V_{rf}/24)^2}{2 \cdot R_S} = 16.3 \text{ kW} \quad \text{and} \quad P_B = I_B \cdot \frac{U_0}{e_0 \cdot 24} = 33.3 \text{ kW},$$

where  $P_{Cin}$  is the cavity coupler input power,  $P_{Cdiss}$  is the copper loss of the cavity and  $P_B$  is the beam loading power. In nominal beam operation the cavity is matched to the generator. Therefore no reflected power will appear. For a matched cavity operation the required coupling factor is:

$$\beta_{match} = 1 + \frac{P_B}{P_{C_{diss}}} = 3.04 .$$

To calculate the transmitter power  $P_{trans}$  at nominal beam operation, 5% transmission losses still have to be considered.

$$P_{trans} = (P_{C_{diss}} + P_B) \cdot 1.05 = 52.1 \text{ kW}$$

The transmitter power at nominal beam operation is  $P_{trans} = 52.1 \text{ kW}$  per cavity.

In order to achieve high reliability and availability some extra power is needed. In case of a cavity or transmitter failure the missing accelerating voltage shall be compensated by the remaining three cavities of the rf system by raising the cavity supply power. This trip compensation should still work even if another rf system is already out of service.

### Fault Mode Operation of the Fundamental RF

Assumptions for beam operation in fault mode are:

- One of the 6 rf systems is already out of service,
- in addition a trip of a component of a remaining rf system occurs

The required voltage per cavity at beam operation with one of the 6 rf systems out of service is:

$$V_C = \frac{V_{rf}}{20} = 400 \text{ kV} .$$

The required power per transmitter at beam operation with one of the 6 rf systems out of service is:

$$P_{trans} = (P_{C_{diss}} + P_B) \cdot 1.05 = 66.8 \text{ kW}$$

with 
$$P_{C_{diss}} = \frac{(V_{rf}/20)^2}{2 \cdot R_S} = 23.5 \text{ kW} \quad \text{and} \quad P_B = I_B \cdot \frac{U_0}{e_0 \cdot 20} = 40.0 \text{ kW} .$$

If in addition a cavity or transmitter trips, the unpowered cavity will extract power from the beam. The part dissipated by the unpowered cavity is:

$$P_{C_{diss}} = \frac{V_B^2}{2 \cdot R_S} = 10.9 \text{ kW}$$

with 
$$V_B = 2 \cdot R_S \frac{1}{1+\beta} \cdot I_B \cdot \cos \varphi = 272.0 \text{ kV} ,$$

where  $\varphi = \arctan \left[ \frac{2 \cdot R_S \cdot I_B}{(1+\beta)V_C} \cdot \cos \psi_S \right] = 36.1^\circ$  is the cavity tuning phase.

The part extracted from the beam by the unpowered cavity is:

$$P_{B_{out}} = 2 \cdot R_S \frac{\beta}{(1+\beta)^2} \cdot I_B^2 \cdot (\cos \varphi)^2 = 32.9 \text{ kW} .$$



The sum of the power extracted from the beam is 43.8 kW and will change the synchronous phase by:

$$\Delta\psi_S = \arcsin\left(\frac{U_0 + \frac{(10.9 + 32.9)kW}{200 \text{ mA}}}{V_{rf}}\right) - \arcsin\left(\frac{U_0}{e_0 \cdot V_{rf}}\right) = 1.8^\circ .$$

Now the rf system with the tripped cavity or transmitter has to deliver 1/5 of the total rf voltage and a corresponding percentage of the power extracted from the beam by the tripped cavity.

The required power for a transmitter of the rf system affected by the tripped cavity is:

$$P_{trans} = (P_{C_{diss}} + P_B) \cdot 1.05 = 104.1 \text{ kW} .$$

with  $P_{C_{diss}} = \frac{\left(\frac{V_{rf}}{5 \cdot 3}\right)^2}{2 \cdot R_S} = 41.8 \text{ kW}$  and  $P_B = I_B \cdot \left(\frac{U_0 + \frac{(10.9+32.9)kW}{200 \text{ mA}}}{5 \cdot 3}\right) = 56.2 \text{ kW} .$

The needed transmitter power at beam operation for each remaining cavity of the rf system affected by the tripped component is  $P_{trans} = 104.1 \text{ kW}$ .

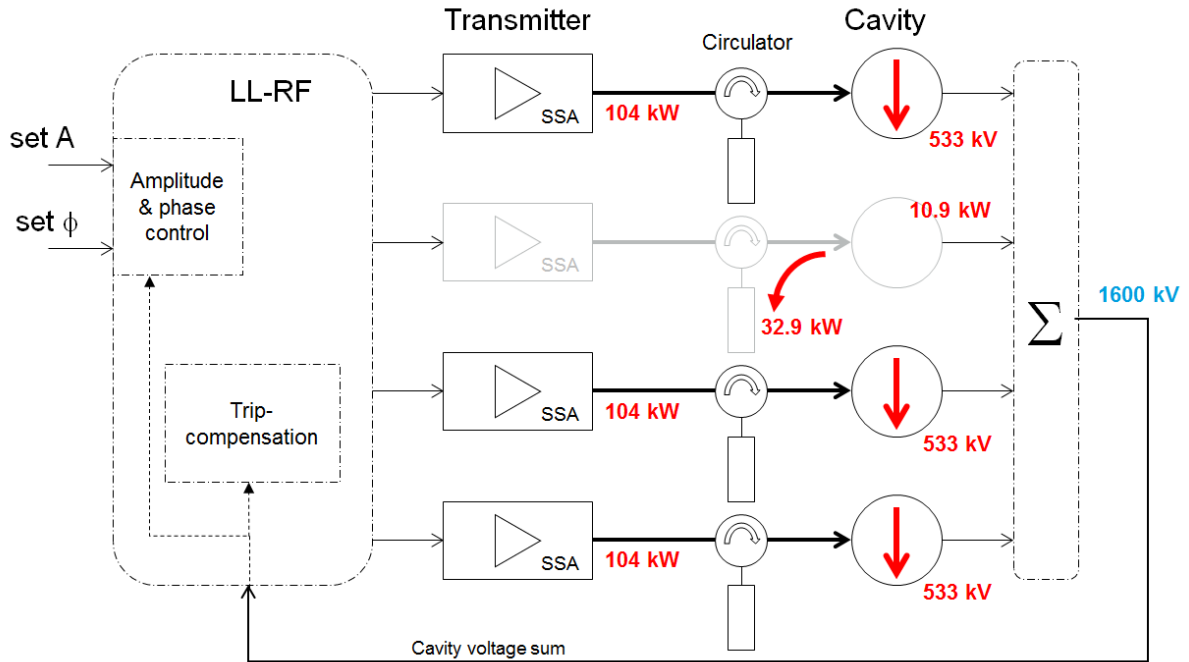

**Fig. 4:** Fault mode beam operation of the fundamental rf. One of the 6 rf systems is already out of service and additionally a cavity or transmitter of a remaining rf system trips

### Installation Site and Visualization of the Radio Frequency System

The radio frequency system is to be built in the south of the PETRA ring. The cavities are to be installed at approximately the same location as the current PETRA III cavities. To connect the 24 fundamental and the 24 harmonic cavities via the shortest way to their transmitters a new hall above the tunnel and in between the current PETRA III transmitter halls has to be built as shown in **Fig. 5**. **Fig. 6** shows how the 24 transmitter systems could be arranged in the new hall, and how the power could be transmitted via waveguides into the tunnel. **Fig. 7** shows the arrangement of the fundamental and the harmonic cavities in the tunnel.

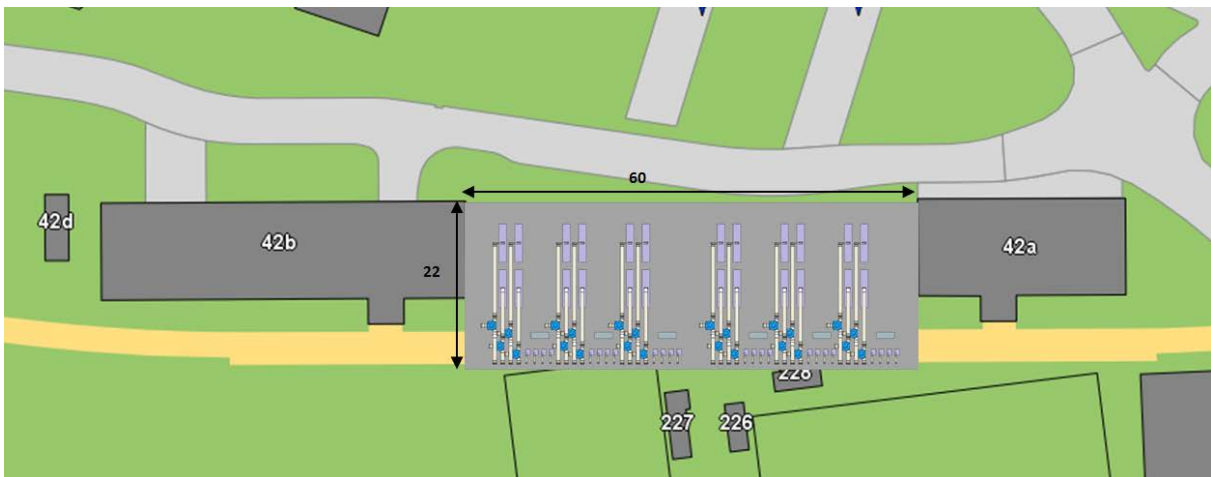

**Fig. 5:** New transmitter hall above the tunnel and in between the current PETRA III transmitter halls

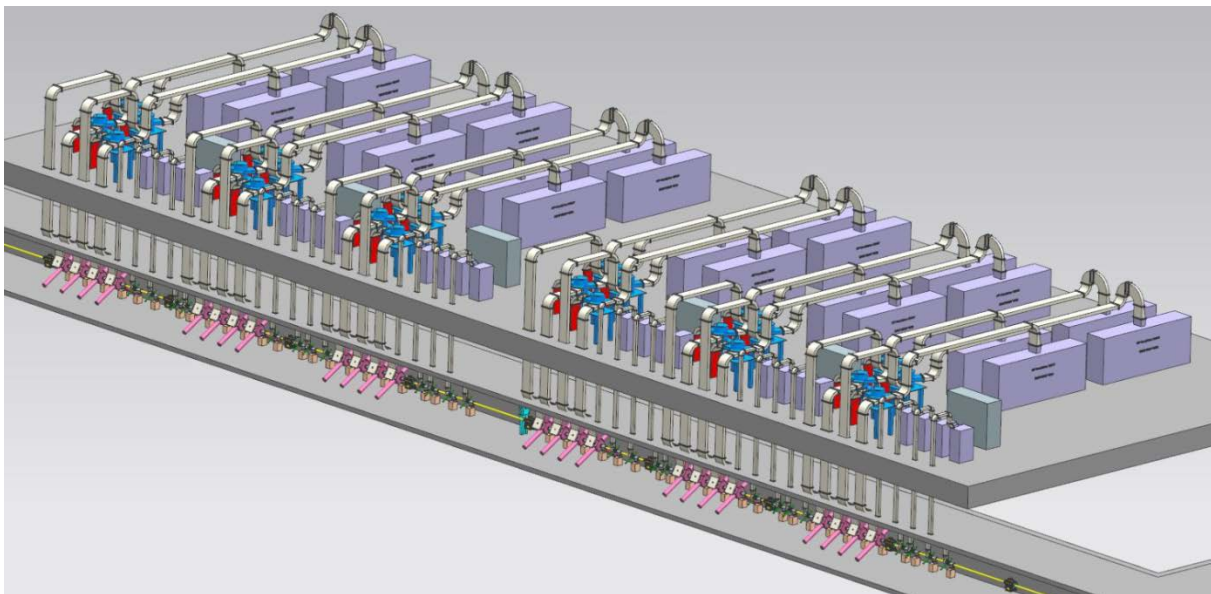

**Fig. 6:** Visualization of the 6 PETRA IV rf systems

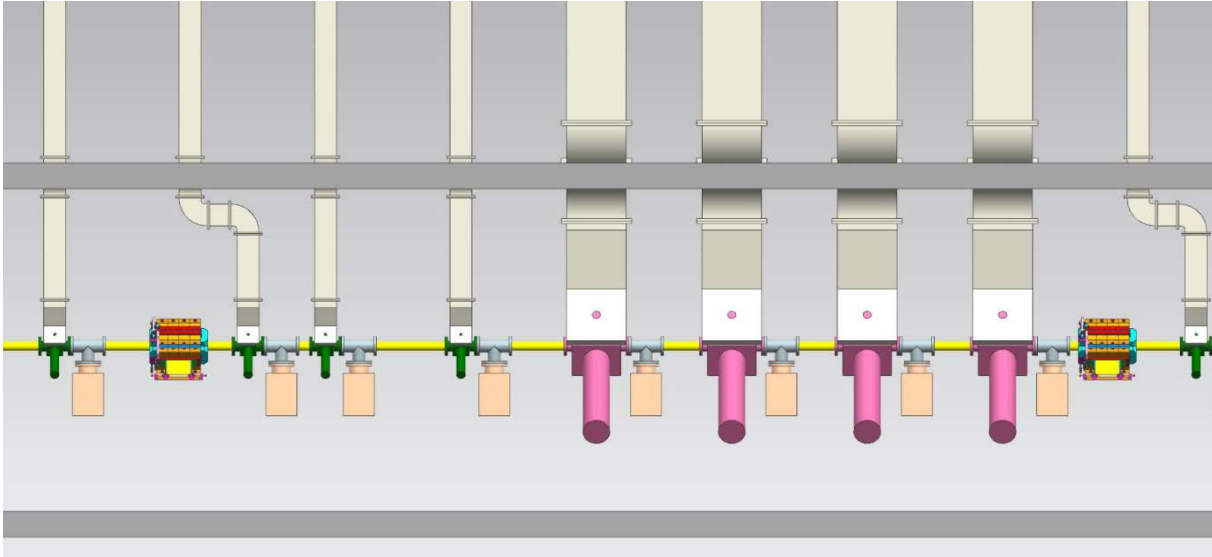

**Fig. 7:** Detailed visualization of one cavity system

## SUMMARY

To upgrade PETRA III to PETRA IV the twelve 7-cell cavities are to be replaced by 24 single-cell cavities. Because of historical reasons PETRA III is driven by the rf power of two transmitters each equipped with two 800 kW klystrons. To minimize the impact of rf faults on the beam, it is reasonable to assign each cavity a dedicated transmitter. Instead of klystron or IOT transmitters, solid state amplifier transmitters are preferred for the PETRA IV rf systems. To avoid a single point of failure the PETRA IV rf is to be divided into 6 independent and uniform rf systems with four fundamental cavities and four harmonic cavities each. The fundamental transmitter power at nominal beam operation will be 52.1 kW per cavity. But in order to compensate a trip of a cavity or a transmitter even in case that one of the 6 rf systems is already out of service, the fundamental transmitter power to be installed has to be 110 kW. Because lifetime and emittance of PETRA IV are negative affected by Touschek and intrabeam scattering, the additional installation of harmonic cavities to lengthen the bunches is necessary. With some safety margin the harmonic system is designed for a harmonic voltage of 2.4 MV. The number of harmonic cavities required is scaled from the fundamental rf system. With the condition of the same gradient of about 1.0 MV/m for the harmonic and for the fundamental cavities, 24 harmonic single-cell cavities are required. The harmonic rf power to be installed is 10 kW per harmonic cavity and is to be provided by one SSA transmitter per cavity. The radio frequency system is to be built in the south of the PETRA ring. The cavities are to be installed at approximately the same location as the existing PETRA III cavities. To connect the 24 fundamental and the 24 harmonic cavities via the shortest way to their transmitters a new hall above the tunnel and in between the current PETRA III transmitter halls has to be built.

## APPENDIX

### Simulation of the Effect of an uneven Bunch Pattern on the Potential Well

For PETRA IV an extreme uneven bunch pattern with just the half ring filled with 40 times 20 bunches was simulated. The simulation was intended to show how revolution harmonics near the resonant frequency of the higher harmonic cavities (HHC) affect the potential well, formed by the fundamental and the harmonic rf systems. The simulation included the beam spectrum from the 1<sup>st</sup> revolution harmonic below  $n f_{rf}$  to the 5<sup>th</sup> revolution harmonic above  $n f_{rf}$ . The results are shown in **Fig. 9.1** to **Fig. 9.6**.

**Fig. 9.1** shows components of cavity voltages in the case of an uniform bunch pattern with 80x20 bunches. The components are the fundamental voltage  $v_{rf}(t)$  (black), the harmonic generator voltage  $v_{HHG}(t)$  (blue), and the beam-induced harmonic voltage  $v_{HHB}(t)$  (red). The purple curve shows the harmonic cavity voltage  $v_{HHC}(t)$ , which is the sum of the harmonic generator voltage and the beam-induced harmonic voltage. The voltage seen by the bunches  $v_{sbb}(t)$  (green) is the sum of the fundamental voltage and the harmonic cavity voltage. The dashed curve (dark grey) represents the potential  $U(\omega t)$ . The potential is the energy a bunch gained from the rf-field of the voltage seen by the bunches (green) minus the energy loss by synchrotron radiation for each phase, integrated over a full fundamental rf frequency period. For optimum lengthening of bunches the potential must form a well with a flat bottom at the phase of bunch transition as showed in **Fig. 9.1**

In case of an uniform bunch pattern with 80x20 bunches the lowest revolution harmonics have a distance of  $80 \cdot f_{rev} = 10.4 \text{ MHz}$ . Hence their effect on the fundamental and harmonic cavities can be neglected. In order to keep the harmonic cavities matched to the generator, they must be detuned according to the beam current. For  $I_B = 200 \text{ mA}$  the required detuning frequency  $\Delta f_{HHC}$  is

$$\Delta f_{HHC} = \frac{R_s \cdot n \cdot f_{rf}}{V_{HHC} \cdot Q_0} \cdot I_B = \frac{36 \text{ M}\Omega \cdot 3 \cdot 500 \text{ MHz}}{2.26 \text{ MV} \cdot 17000} \cdot 200 \text{ mA} = 280 \text{ kHz}$$

The harmonic rf system should not supply power to the beam. Hence the optimum cavity coupling factor must be  $\beta = 1$ .

The resulting cavity detuning phase is

$$\varphi_{HHC} = \arctan\left(\frac{2}{1 + \beta} \cdot \frac{R_s}{V_{HHC}} \cdot I_B\right) = \arctan\left(\frac{2}{1 + 1} \cdot \frac{36 \text{ M}\Omega}{2.26 \text{ MV}} \cdot 200 \text{ mA}\right) = 72,5^\circ$$

The required harmonic generator power is

$$P_{HHG} = \frac{(1 + \beta)^2}{4\beta} \frac{V_{HHC}^2}{2 \cdot R_s} = \frac{(1 + 1)^2}{4} \frac{(2.26 \text{ MV})^2}{2 \cdot 36 \text{ M}\Omega} = 71 \text{ kW}$$

The rf phase of the harmonic generator with respect to the bunches is  $\phi_{HHG} = 0^\circ$

**Fig. 9.2** shows components of cavity voltages in case of an uneven bunch pattern. In this example it was assumed, that only one half of the ring is filled with 80x20 bunches. Because of the appearing

harmonics of the revolution frequency  $f_{rev} = 130.121 \text{ kHz}$  in interaction with the detuned cavities the beam-induced harmonic voltage (red) is affected in amplitude and phase. As a result the curves of the voltage seen by the bunches (green) and the potential are also deformed. The rf parameters  $\phi_{HHG}$  and  $P_{HHG}$  are unchanged with respect to **Fig. 9.1**. Merely the detuning of the cavities differs due to the halved beam current.

$$\Delta f_{HHC} = \frac{R_s \cdot n \cdot f_{rf}}{V_{HHC} \cdot Q_0} \cdot I_B = \frac{36 \text{ M}\Omega \cdot 3 \cdot 500 \text{ MHz}}{2.26 \text{ MV} \cdot 17000} \cdot 100 \text{ mA} = 140 \text{ kHz}$$

$$\phi_{HHC} = \arctan\left(\frac{2}{1 + \beta} \cdot \frac{R_s}{V_{HHC}} \cdot I_B\right) = \arctan\left(\frac{2}{1 + 1} \cdot \frac{36 \text{ M}\Omega}{2.26 \text{ MV}} \cdot 100 \text{ mA}\right) = 57,9^\circ$$

Note: The harmonic cavities are detuned by 140 kHz and therefore almost on resonance with the 1<sup>st</sup> revolution harmonic above  $n \cdot \omega_{RF}$ !

**Fig. 9.3.** shows a way to solve the problem. The effect of the revolution harmonics on the beam-induced harmonic voltage (red) can be compensated by a matched change of generator phase and amplitude. Reducing the generator phase to  $\phi_{HHG} = -32^\circ$  and increasing the generator power to  $P_{HHG} = 650 \text{ kW}$  reproduces the initial conditions as shown in **Fig. 9.1**. However, providing 650 kW harmonic generator power for extremely uneven but unlikely bunch pattern seems exorbitant, particularly with regard to normal operation where only 71 kW are required. The required power for uneven bunch pattern can be reduced by a stronger coupling of the harmonic cavities as shown in **Fig. 8.**

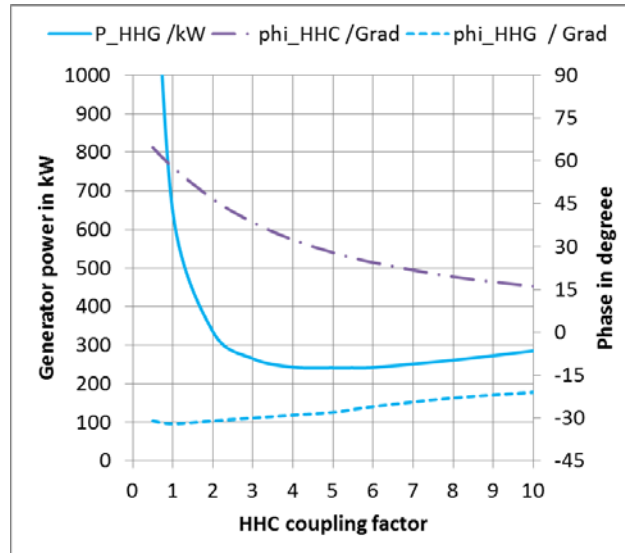

**Fig. 8:** Required harmonic generator power  $P_{HHG}$ , generator phase  $\phi_{HHG}$  and cavity tuning phase  $\phi_{HHC}$  versus coupling factor  $\beta$  for the assumed uneven bunch pattern. The harmonic generator power curve (blue) shows a flat minimum at  $\beta = 5.3$ . For  $\beta < 2$  the required harmonic generator power rises very strong. In contrast, for  $\beta > 5.3$  the power rises rather weak. Conveniently, the coupling factor can be between  $4 < \beta < 6$

**Fig. 9.5** shows the same situation as in **Fig. 9.3**, but with stronger coupling of the harmonic cavities and the reduced harmonic generator power as a result.

The advantage of stronger coupling for uneven bunch pattern unfortunately has the disadvantage that more generator power is required for normal operation. See **Fig. 9.6** and compare to **Fig. 9.1**.

## Legend to Fig. 9

### Fundamental voltage

$$v_{rf}(t) = \hat{V}_{rf} \cdot \sin(\omega_{rf} \cdot t + \Psi_s)$$

$\hat{V}_{rf}$  peak value of the fundamental voltage

$\Psi_s$  synchronous phase (from 0-crossing of the rising sine curve slope to the bunch position)

### Generator voltage

$$v_{HHG}(t) = \frac{2\sqrt{\beta}}{1+\beta} \cdot \sqrt{2 \cdot P_{HHG} \cdot R_s} \cdot \cos \varphi_{HHC} \cdot \sin(n \cdot \omega_{rf} \cdot t + \phi_{HHG} - \varphi_{HHC})$$

$\frac{2\sqrt{\beta}}{1+\beta} \cdot \sqrt{2 \cdot P_{HHG} \cdot R_s} \cdot \cos \varphi_{HHC}$  peak value of the HHC generator voltage with harmonic cavity detuned by  $\varphi_{HHC}$

$\beta$  coupling factor of the harmonic cavity

$P_{HHG}$  forward generator power

$\phi_{HHG}$  generator phase

$\varphi_{HHC}$  detuning phase of the harmonic cavity

### Beam-induced voltage

$$v_{HHB}(t) = \frac{2}{1+\beta} \cdot R_s \cdot I_B \cdot \sum_{m=-1}^{m=5} \left[ k_m \cdot \cos \varphi_{HHCm} \cdot \cos \left( (n \cdot \omega_{rf} + m \cdot \omega_{rev}) \cdot t - \varphi_{HHCm} \right) \right]$$

$\frac{2}{1+\beta} \cdot R_s \cdot I_B$  peak value of the beam-induced voltage with harmonic cavity on resonance

$n$  harmonic number

$m$  revolution harmonic number below (-) respective above (+)  $n \cdot \omega_{rf}$

$k_m$  amplitudes of the revolution harmonic  $n \cdot \omega_{rf} + m \cdot \omega_{rev}$  divided by the amplitude of  $n \cdot \omega_{rf}$ .

For the simulated bunch pattern the relevant  $k_m$  are:

$k_{-1} = 0.646; k_0 = 1; k_1 = 0.646; k_2 = 0; k_3 = 0.211; k_4 = 0; k_5 = 0.141$

$\varphi_{HHCm}$  detuning phase of the harmonic cavity with respect to the revolution harmonic  $n \cdot \omega_{rf} + m \cdot \omega_{rev}$

### Harmonic cavity voltage

$$v_{HHC}(t) = v_{HHB}(t) + v_{HHG}(t)$$

### Voltage seen by the bunches

$$v_{sbb}(t) = v_{rf}(t) + v_{HHB}(t) + v_{HHG}(t)$$

### Potential

$$U(\omega t) = -\frac{1}{T} \cdot \int_{\omega t = -\pi}^{\omega t = \pi} (e_0 v_{sbb}(\omega t) - U_0) d\omega t + C$$

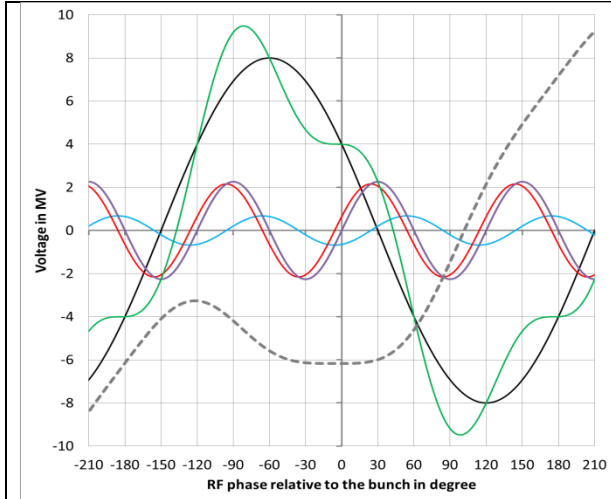

**Fig. 9.1:** Brightness mode bunch pattern with 80x20 bunches  
 $I_B = 200 \text{ mA}$ ,  $P_{\text{HHG}} = 71 \text{ kW}$ ,  $\phi_{\text{HHG}} = 0^\circ$ ,  $\beta = 1$ ,  $\varphi_{\text{HHC}} = 72.5^\circ$

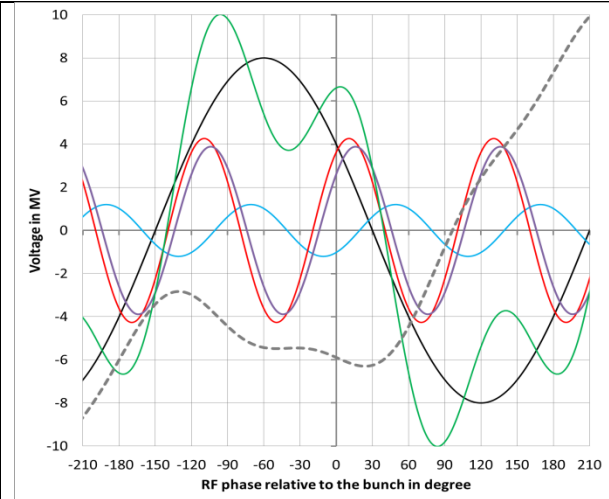

**Fig. 9.2:** Uneven bunch pattern. Half ring filled with 40x20 bunches  
 $I_B = 100 \text{ mA}$ ,  $P_{\text{HHG}} = 71 \text{ kW}$ ,  $\phi_{\text{HHG}} = 0^\circ$ ,  $\beta = 1$ ,  $\varphi_{\text{HHC}} = 57.8^\circ$

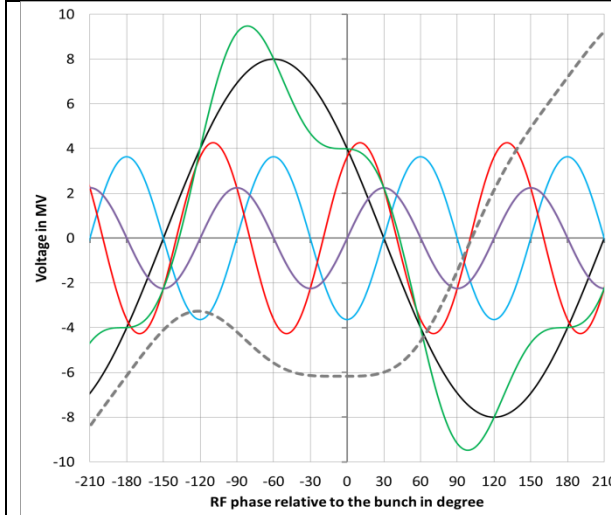

**Fig. 9.3:** Uneven bunch pattern. Half ring filled with 40x20 bunches  
 $I_B = 100 \text{ mA}$ ,  $P_{\text{HHG}} = 650 \text{ kW}$ ,  $\phi_{\text{HHG}} = -32^\circ$ ,  $\beta = 1$ ,  $\varphi_{\text{HHC}} = 57.8^\circ$

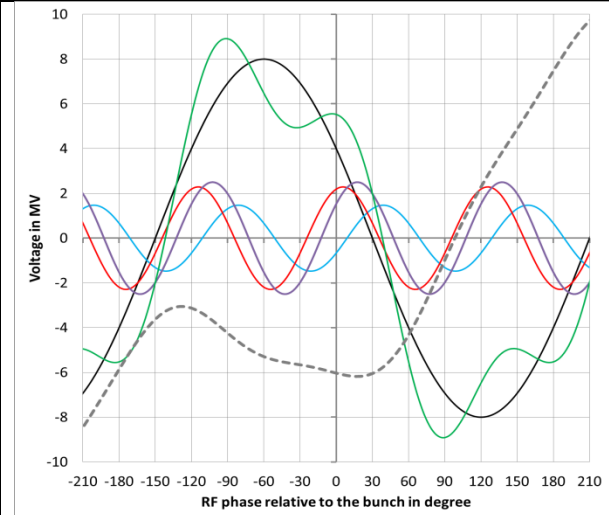

**Fig. 9.4:** Uneven bunch pattern. Half ring filled with 40x20 bunches  
 $I_B = 100 \text{ mA}$ ,  $P_{\text{HHG}} = 71 \text{ kW}$ ,  $\phi_{\text{HHG}} = 0^\circ$ ,  $\beta = 5.3$ ,  $\varphi_{\text{HHC}} = 26.8^\circ$

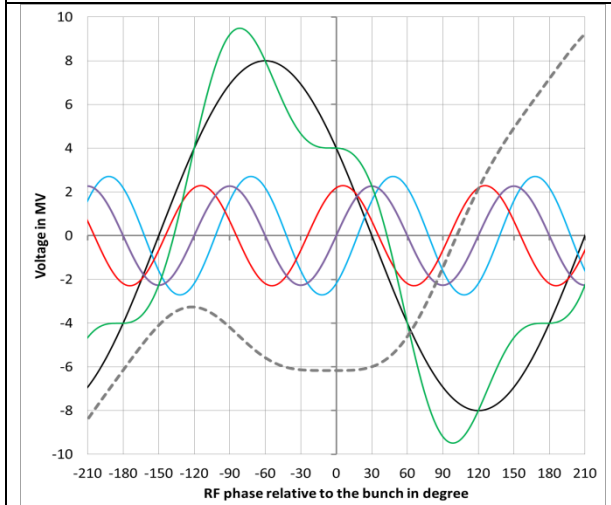

**Fig. 9.5:** Uneven bunch pattern. Half ring filled with 40x20 bunches  
 $I_B = 100 \text{ mA}$ ,  $P_{\text{HHG}} = 240 \text{ kW}$ ,  $\phi_{\text{HHG}} = -27^\circ$ ,  $\beta = 5.3$ ,  
 $\varphi_{\text{HHC}} = 26.8^\circ$

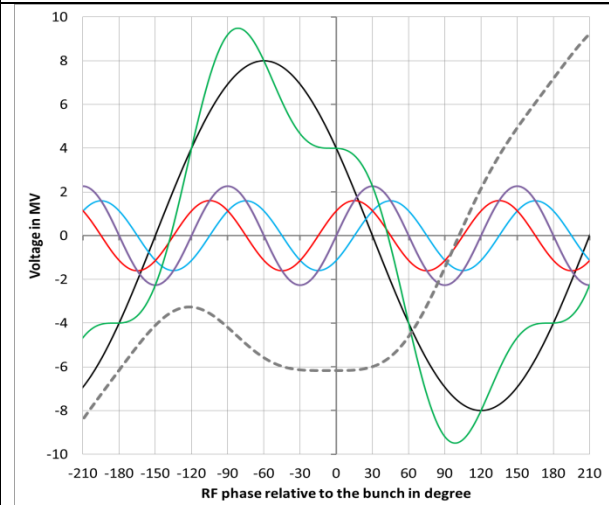

**Fig. 9.6:** Brightness mode bunch pattern with 80x20 bunches  
 $I_B = 200 \text{ mA}$ ,  $P_{\text{HHG}} = 134 \text{ kW}$ ,  $\phi_{\text{HHG}} = 0^\circ$ ,  $\beta = 5.3$ ,  $\varphi_{\text{HHC}} = 45.3^\circ$

## PETRA IV PARAMETERS

**Table 1:** Essential PETRA IV parameters for the rf system design

Beam energy	6 GeV	
	Brightness Mode	Timing Mode
Beam current	200 mA	80 mA
Number of Bunches	1600 (=80 x 20)	80 (=80 x 1)
Bunch spacing	4 ns	96 ns
Bunch filling gap	20 ns	96 ns
Harmonic number	3840	
Revolution frequency	130.121 kHz	
Energy loss per turn	4.02 MeV	
	in bending magnets	
	1.32 MeV	
	in insertion devices	
	2.70 MeV	
Momentum compaction factor	$1.485 \times 10^{-5}$	

**Table 2:** Parameters for the PETRA IV fundamental rf system

rf frequency	499.665 MHz
rf voltage	8 MV
Synchronous phase	30.2 °
Synchrotron frequency	421 Hz
Number of single-cell cavities	24
rf voltage per cavity	333 kV
Shunt impedance per cavity	3.4 MΩ
Unloaded quality factor	29,600
Loaded quality factor	7,400
Total wall loss in cavities	392 kW
Total beam loading power	800 kW
Cavity coupling factor	3.0
Number of rf stations	24
Nominal transmitter power per rf station	110 kW

**Table 3:** Parameters for the PETRA IV 3<sup>rd</sup> harmonic rf system

rf frequency	1498.995 MHz
rf voltage	2.26 MV
Number of single-cell cavities	24
rf voltage per cavity	94 kV
Shunt impedance per cavity	1.5 MΩ
Unloaded quality factor	17,000
Loaded quality factor	2,700
Total wall loss in cavities	71 kW
Cavity coupling factor	5.3
Number of rf stations	24
Nominal transmitter power per rf station	10 kW



## REFERENCES

- [1] F. Marhauser, E. Weihreter; *FIRST TESTS OF A HOM-DAMPED HIGH POWER 500 MHZ CAVITY*, EPAC 2004, Lucerne, Switzerland
- [2] F. Marhauser, E. Weihreter; *HOM DAMPED 500 MHZ CAVITY DESIGN FOR 3RD GENERATION SR SOURCES*; 2001 Particle Accelerator Conference, Chicago
- [3], E. Weihreter, *THE BESSY HIGHER ORDER MODE DAMPED CAVITY*, ESLS-RF Meeting September 2010, ELETTRA, Trieste
- [4] W. Anders et. al., *RENEWAL OF BESSY II RF SYSTEM. SOLID STATE AMPLIFIERS AND HOM DAMPED CAVITIES*; IPAC 2017, Copenhagen, Denmark
- [5] J. Jacob et. al.; *352.2 MHz – 150 KW SOLID STATE AMPLIFIERS AT THE ESRF*; IPAC 2011, San Sebastián, Spain
- [6] J. M. Byrd, M. Georgsson; *LIFETIME INCREASE USING PASSIVE HARMONIC CAVITIES IN SYNCHROTRON LIGHT SOURCES*, PhysRevSTAB.4.030701; 2001
- [7] Beatriz Bravo; *1.5 GHZ CAVITY DESIGN FOR THE CLIC DAMPING RING AND AS ACTIVE THIRD HARMONIC CAVITY FOR ALBA*; IPAC 2017, Copenhagen, Denmark
- [8] J. M. Byrd et. al.; *TRANSIENT BEAM LOADING EFFECTS IN HARMONIC RF SYSTEMS FOR LIGHT SOURCES*; PhysRevSTAB.5.092001; 2002
- [9] A. Salom et. al., *ALBA LLRF UPGRADES TO IMPROVE BEAM AVAILABILITY*, IPAC 2015, Richmond, VA, USA
- [10] A. Salom et. al., *LATEST DEVELOPMENTS OF THE ALBA DLLRF*, IPAC 2017, Copenhagen, Denmark